

Operating instructions for operators and installers

Electronic index EI5.00/EI5.03

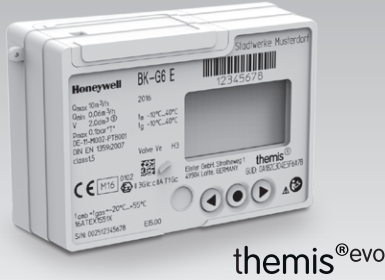

Contents

Electronic index EI5.00/EI5.03 1

Contents 1

Safety 1

Checking the usage 2

Type code 2

Part designations 2

Index labelling 2

Supplier guidance 2

Installation 3

Operating the electronic index 3

Symbols, selection key, navigation keys 3

Navigating within the menu 4

Menu overview 4

Current meter reading 4

Engineer menu 4

Valve open test 4

Commissioning 4

Tariff information 5

Supplier information 5

Diagnostic services 5

Enter UTRN (Unique Transaction Reference Number) 5

Date and time 6

Meter information 6

Firmware traceability 6

Service mode 7

Establishing an optical communications link 8

Changing the battery 9

Releasing the valve 9

Check test 10

Cyclic test at a constant flow rate 10

Cyclic test with a given volume 11

RTC test 12

Temperature test 12

Assistance in the event of malfunction 13

Maintenance 13

Spare parts 13

Technical data 13

Logistics 14

Contact 14

Safety

Please read and keep in a safe place



Please read through these instructions carefully before installing or operating. Following the installation, pass the instructions on to the operator. This unit must be installed and commissioned in accordance with the regulations and standards in force. These instructions can also be found at www.docuthek.com.

Explanation of symbols

- , 1, 2, 3... = Action
- ▷ = Instruction

Liability

We will not be held liable for damage resulting from non-observance of the instructions and non-compliant use.

Safety instructions

Information that is relevant for safety is indicated in the instructions as follows:

⚠ DANGER

Indicates potentially fatal situations.

⚠ WARNING

Indicates possible danger to life and limb.

! CAUTION

Indicates possible material damage.

All interventions may only be carried out by qualified gas technicians. Electrical interventions may only be carried out by qualified electricians.

Conversion, spare parts

All technical changes are prohibited. Only use OEM spare parts.

Checking the usage

Electronic index EI5.00/EI5.03 for diaphragm gas meters BK..E and BK..ET

For reading out absolute consumption values and the valve position as well as for retrieving consumption data for the various tariffs.

The national statutory regulations must be observed. This function is only guaranteed when used within the specified limits – see page 13 (Technical data). Any other use is considered as non-compliant.

Type code

Code	Description
EI	Electronic index
5.00	Wireless technology: 2.4 GHz Zigbee SMETS2
5.03	Wireless technology: 2.4 GHz, Zigbee SMETS1
5.04	as EI5.03 with optical interface
5.06	as EI5.00 with optical interface

Part designations

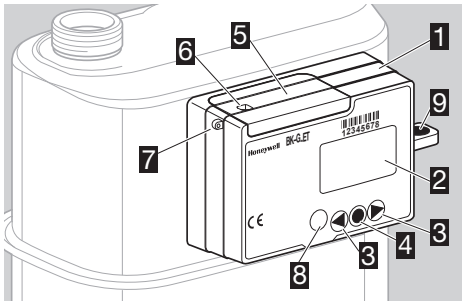

- 1 Electronic index EI5.0x
- 2 Display
- 3 Navigation keys
- 4 Selection key
- 5 Battery cover
- 6 Installation seal
- 7 Lug for sealing the connections
- 8 Optical interface (EI5.04 and EI5.06)
- 9 Metrological seal

Index labelling

Index version EI5.0x, ambient temperature t_m , IP enclosure, flow rate Q , operating pressure p_{max} , see index.

Please quote for all enquiries:

- ▷ Manufacturer's serial number **S/N** (at the bottom edge of the index)
- ▷ Index version EI5.0x (next to the serial number).

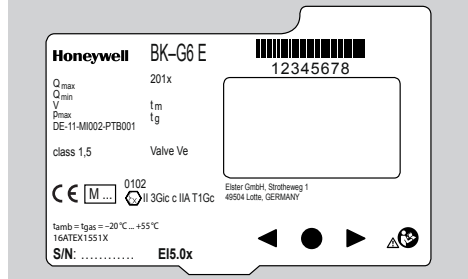

ATEX

- ▷ The electronic index is suitable for use in potentially explosive atmospheres. For the exact use (zone), see ATEX marking on the index or see the operating instructions for diaphragm gas meters BK-G1.6 to BK-G25 → www.docuthek.com.

Supplier guidance

- ▷ As part of the commissioning process, the energy supplier should ensure that the meter clock is set correctly via a "Set clock" command.
- ▷ Once commissioning has been completed successfully, all responses to commands sent from the head end to the meter should be continually monitored. In particular, commands should be expected to be responded to with a success and/or actioned response. Further investigation should be undertaken if commands receive a failed response. Future dated command responses should also be monitored at the time of sending and expected execution.
- ▷ Following successful commissioning to the relevant network, it is recommended that, within 7 days, the meter is issued with an "Issue security credentials" command to instruct the meter to generate new security credentials.
- ▷ The security log should be read by the energy supplier frequently enough to ensure no security events are overwritten before being read. The security log contains a maximum of 100 entries with a recommended read of at least once per week.
- ▷ When a meter is being used for prepayment purposes, energy suppliers should regularly check to ensure top-ups applied to the meter are aligned with those expected.

- ▷ Prior to meter removal, it is recommended that the energy supplier deletes or overwrites sensitive information on the meter to ensure consumer data protection. As a minimum, this should include deletion of any customer identification information (e.g. CIN and MPRN).

Installation

Installing the gas meter

- ▷ For installing the gas meter in the pipework, refer to the operating instructions for diaphragm gas meters BK-G1.6 to BK-G25 → www.docuthek.com.
- ▷ Ensure that the signal strength at the installation site exceeds -80 dBm with the gas meter and communications hub at their final point of installation. Anything less than -80 dBm may impact installation success and meter lifetime.
- ▷ To ensure that neither persons are injured nor the gas meter damaged and that secure operation of the meter is maintained during installation and operation, refer to the installation guideline warnings in the operating instructions for diaphragm gas meters BK-G1.6 to BK-G25 → www.docuthek.com.

Gas meter with integrated valve

- ▷ If the integrated shut-off valve in the gas meter is closed, it must be released, see page 9 (Releasing the valve).

Operating the electronic index

- If the display on the index is switched off, press one of the keys briefly.

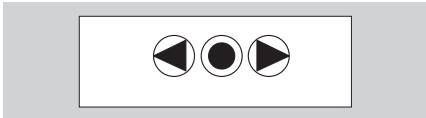

- ▷ A beep sounds and the main screen appears.
- ▷ An internal buzzer gives audible feedback, e.g. a short beep indicates a valve is open and a long beep indicates a valve is closed. A short beep sounds each time a key is pressed or if the unit automatically changes back to the main screen.

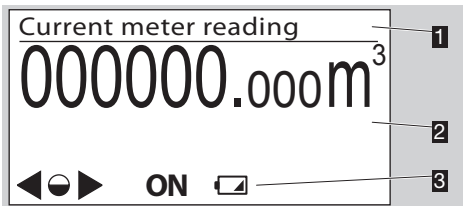

- 1 Menu area
- 2 Information area
- 3 Status line (symbols)
 - ▷ The **ON/OFF** symbols are only displayed when a valve is integrated in the gas meter.
 - ▷ In certain cases, a status display appears first. After 30 s, the display automatically switches to the main screen.

Symbols, selection key, navigation keys

- ▷ Navigate through the menu with the navigation keys **▶**, **◀** and the selection key **●**.

Symbol	Meaning
▶ , ◀	Navigate to the left or the right on each level using the navigation keys.
●	Briefly pressing the selection key selects a sub-menu. Holding the selection key pressed down switches the display back to the previous menu.
◐	Briefly pressing the selection key selects a sub-menu.
◑	Holding the selection key pressed down switches the display back to the previous menu.
▶ , ○ , ◀	Keys inactive
OFF	Valve/gas flow closed. This symbol is only displayed when a valve is integrated in the gas meter.
ON	Valve/gas flow released. This symbol is only displayed when a valve is integrated in the gas meter.
⚠	Invalid data
⚠	Fault message
🔋	Low battery. This symbol is only displayed when battery power is low.
*	Marking for metrology-relevant data

Navigating within the menu

- ▷ The menu is constructed hierarchically.
- ▷ Depending on the configuration, some menu options may be missing.
- ▷ The “Current meter reading” main screen appears when switching on the index.
- ▷ If a different menu is active, the display will automatically change back to the main screen when no navigation key has been pressed for 30 s, and switches off after a further 30 s.
- ▷ Navigate from the main screen to the various menus, such as “Meter information”, with the navigation keys ▶, ◀.

Menu overview

Display and order may differ, depending on the configuration.

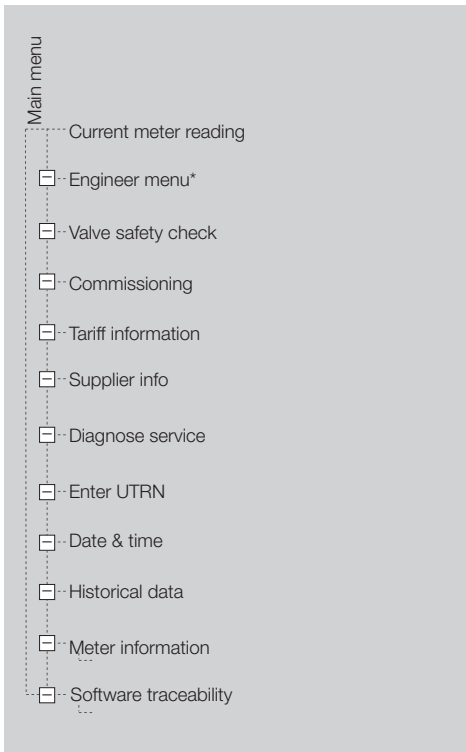

* On EI5.00, this menu option can only be selected if the battery cover is open.

Current meter reading

- ▷ The absolute meter reading and optionally the current tariff are indicated in the main screen.
- ▷ This appears when the index is switched on.
- ▷ Information about the symbols is displayed when pressing the selection key ● and the navigation keys ▶, ◀.

Engineer menu

- ▷ On EI5.00, this menu option is only available if the battery cover has been removed from the index.
- ▷ Sub-menus can be opened by pressing the selection key. Depending on the configuration, a four-digit PIN must be entered. For entering the PIN, see page 5 (Supplier information).
- ▷ The Engineer menu can be used for checking the valve, preparing the battery change procedure or displaying the security log.

Valve open test

- ▷ The “Valve open test” menu option is only displayed if the meter has received a command to open the valve.
- ▷ If the valve was released while the display was switched off, the release note will appear the next time the index is switched on.



- ▷ The note remains active until the valve has been released, see page 9 (Releasing the valve).
- ▷ If the selection key ● is not pressed, the display will switch back to the main screen after 30 s.

Commissioning

- ▷ Hold the selection key pressed down to start the commissioning procedure.
- ▷ When the meter instigates a join to the network, it should use ZSE cryptography CBKE to successfully establish a shared secret key with the communications hub, requesting the creation of mirrored Basic, Metering and Prepayment Clusters from the ZigBee Gas ESI Endpoint, checking any command received to make sure it is well formed and valid.
- ▷ The meter should also be able to communicate with other devices on the network where their relevant security credentials and device identifiers have been provided securely, from an authorized and trusted source, and stored in the meter's device log.

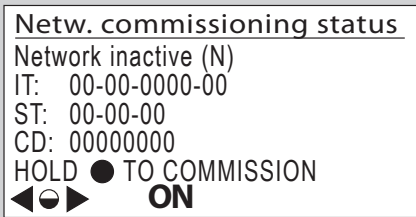

- ▷ The signal strength at the installation site should exceed -80 dBm. Otherwise, communications with the Trust Centre will be impaired and the service life of the battery will be reduced.
- ▷ As part of the commissioning process, the meter clock should be set correctly by the DCC. Once this command has been actioned, the meter clock should be checked to ensure the date and time are correct – see page 8 (Date and time).
- ▷ Once successfully commissioned, the meter only stores data relevant to itself and other authorized devices within the device log, without holding security data that could compromise these or any other devices.

Tariff information

- ▷ Sub-menus can be opened by pressing the selection key.
- ▷ Information on TOU tariffs or block tariffs can be visualized depending on the tariff set.

Supplier information

- ▷ Information on the gas supplier is displayed.

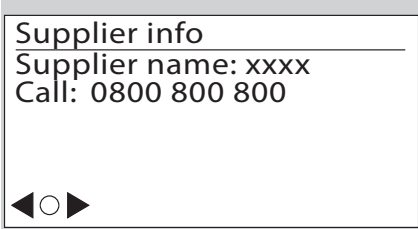

- ▷ Sub-menus can be opened by pressing the selection key. Depending on the configuration, a four-digit PIN must be entered.
- ▷ The end user should ensure the security of any PIN created, for example:
 - Don't write your PIN down.
 - Choose a good PIN (random to anyone else but you).
 - Don't use the same PIN for multiple devices.
 - Never divulge your PIN to anyone.
 - Be careful when entering PIN numbers: be aware of who may be watching.
 - If you think your PIN may have been compromised, change it as soon as you can.

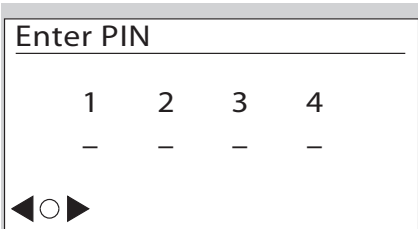

- 1** Press the navigation keys. The selected digit is incremented or decremented.
- 2** Select the next digit by pressing the selection key.

- 3** Enter all digits as described above.
- 4** Once all digits have been entered, press the selection key and hold down.
 - ▷ If the entry is correct, the display switches to the protected menu area.
 - ▷ It is possible to navigate between the following screens (not illustrated) using the navigation keys:
 - Customer information
 - PIN management
 - Meter balance
 - Tariff information
 - ▷ Depending on the configuration, some screens may be missing.

Diagnostic services

- ▷ Depending on the configuration, a menu is displayed which can be used to diagnose connection issues.

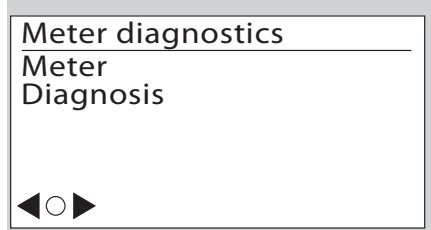

- ▷ Sub-menus can be opened by pressing the selection key.
- ▷ It is possible to navigate between the following screens (not illustrated) using the navigation keys:
 - Network info
 - Event log

Enter UTRN (Unique Transaction Reference Number)

- ▷ The UTRN can be entered in Prepayment mode.

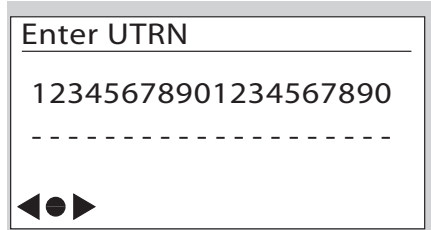

- 1** Press the navigation keys. The selected digit is incremented or decremented.
- 2** Select the next digit by pressing the selection key.
- 3** Enter all digits as described above.
- 4** Once all digits have been entered, press the selection key and hold down.
 - ▷ If the entry is correct, confirm the "Top-Up OK" message using the selection key ●. The display changes to the main screen.
 - ▷ In the case of an incorrect entry, briefly press the selection key ●. The UTRN can be entered up to a maximum of ten times.

- ▷ Should a UTRN be entered that has either been manually or remotely entered into the meter before, the meter will reject the entry, displaying that a "Duplicate UTRN" has been entered.

Date and time

- ▷ Information on the date and time display.
- ▷ Description, see Service mode, page 8 (Date and time).

Meter information

- ▷ Meter-specific technical data are displayed in sub-menus by pressing the navigation keys **▶**, **◀** and the selection key **●**.

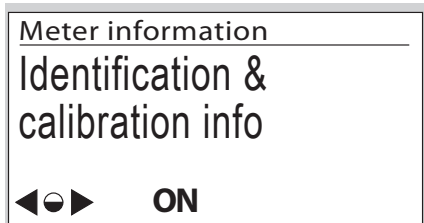

- ▷ Other screen descriptions for the software versions (not illustrated):

Protected/Unprotected/Bootloader version:

- Version = firmware version
- CRC = checksum
- Details = firmware details
- Year of manufacture

- ▷ Other screen descriptions (not illustrated):

Calibration information:

Meter calibration parameters Q1 to Q3 (adjustment values Q1 to Q3 for three-point calibration)

Meter properties:

- V = cyclic meter volume
- Q_t = transitional flow rate
- EN 1359 certification number

Ambient conditions:

- Ex = electromagnetic
- Mx = mechanical

Firmware traceability

- ▷ The events shown are saved in the non-volatile permanent log memory.
- ▷ The metrology-relevant system events, e.g. firmware upgrades, restarts, low voltage, etc., are stored in the permanent log memory.
- ▷ The events in the permanent log have unique numbers, e.g.:
2 → firmware upgrade
15 → restart command
16 → restart
- ▷ Only events which are relevant for the firmware history are listed in the "Firmware traceability" sub-menu.

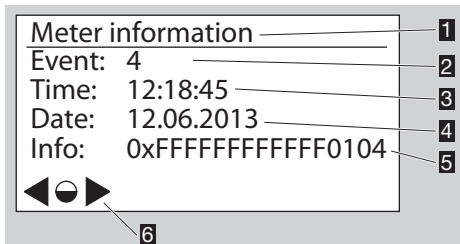

- 1** Menu description
- 2** Event: event that has occurred; can be assigned the number 2, 15 or 16
- 3** Time: time at which the event occurred
- 4** Date: date on which the event occurred
- 5** Info: additional data, as explained below
- 6** Navigation symbols

In the case of event 2, "Firmware upgrade", the meaning of the additional data is as follows:

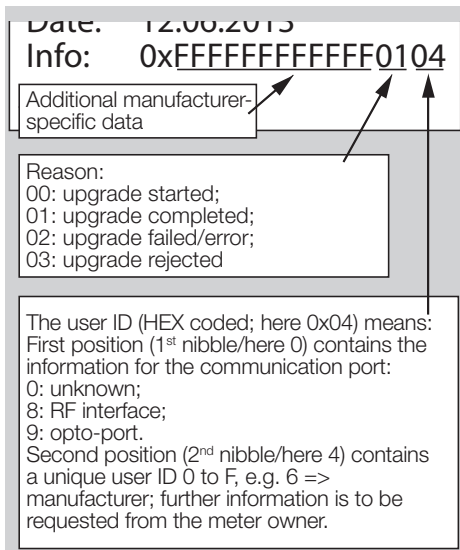

In the case of event 15 “Restart command” and event 16 “Restart”, the meaning of the additional data is as explained below:

- ▷ The HEX values must always be itemized in pairs (1 byte).
- ▷ The HEX values of the firmware version are displayed “LSB first” coded.
- ▷ LSB first: least significant byte first.
- ▷ MSB first: most significant byte first.

Date: 12.08.2013
Info: 0xXXXX 7DFE 1D150104
<div style="border: 1px solid black; padding: 2px; width: fit-content;">Additional manufacturer-specific data</div>
Checksum (CRC), e.g.: 0x7DFE (MSB first coded)
Version information, e.g.: 0x1D1501 (display: LSB first) => 0x01151D (HEX, MSB first coded) => 01.21.29 (DEC, MSB first coded)
<p>The user ID (HEX coded; here 0x04) means: First position (1st nibble/here 0) contains the information for the communication port: 0: unknown; 8: RF interface; 9: opto-port. Second position (2nd nibble/here 4) contains a unique user ID 0 to F, e.g. 6 => manufacturer; further information is to be requested from the meter owner.</p>

Service mode

- ▷ In Service mode, meter-specific operating data can be called up.

Activating Service mode

- 1** Hold the selection key ● pressed down.
- ▷ A pixel will appear in each corner of the display.
- 2** Observe one pixel: while the pixel is visible, hold the selection key ● pressed down. Release the key as soon as the pixel has disappeared.
- 3** Repeat the process, until all the pixels are off and “Test instructions” appears in the menu area.
- ▷ Service mode is activated.
- ▷ You can navigate through the menu using the navigation keys ▶, ◀ and the selection key ●.

Service mode menu overview

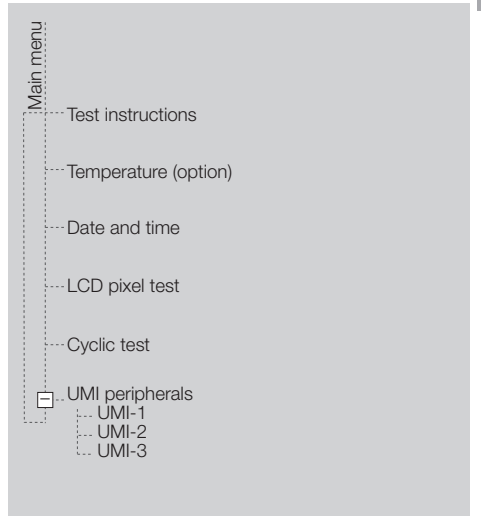

Test instructions

<p>Test instructions</p> <p>Automatic return to main menu after 5 minutes of inactivity</p> <p>Hold ● on any screen to return immediately</p> <p style="text-align: center;">◀ ● ▶ ON</p>
--

Temperature

- ▷ The current gas temperature is displayed.

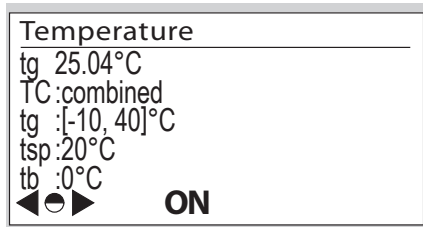

- ▷ Check test for temperature measurement, see page 10 (Check test).
- ▷ The measured values are updated once per minute.

Date and time

- ▷ Information on the date and time display.

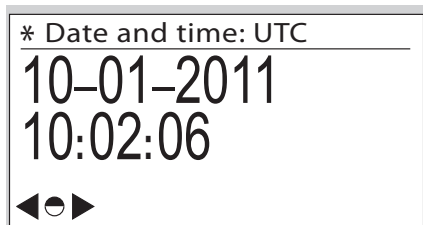

- ▷ The date is given in the format day – month – year.
- ▷ The date and time are only visible if access to the historic meter readings has been enabled.

LCD pixel test

- ▷ A display test can be carried out in this menu.

- 1 Follow the displayed instructions.
- ▷ A test pattern is shown in the display.
- 2 Briefly press the selection key ●.
- ▷ A further test pattern appears in the display.
- 3 Hold the selection key pressed down. The display switches to the previous menu.

Cyclic test

- ▷ The accuracy of the meter can be checked using a cyclic test.
- ▷ For detailed information on the check test operating sequence, see page 10 (Check test).

UMI peripherals

- ▷ The status of the available interfaces for optional communication modules is displayed.

Establishing an optical communications link

- ▷ Depending on the configuration, the optical interface can be locked.
- ▷ In order to configure the electronic index for the respective application, the optical communications link must be activated.

- 1 Position the opto-adapter head on the interface provided.

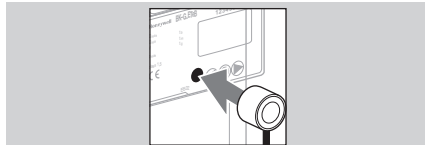

- 2 Press any of the navigation keys.
 - ▷ Optical communication is enabled for 1 minute.
 - ▷ If the optical communications link is not used during this time, the interface will be deactivated.
- 3 Initiate communication.
 - ▷ The procedure depends on the user software.

Changing the battery

⚠ WARNING

Risk of explosion in explosion-hazard areas!

- As a general rule, maintenance and repair work should be avoided in explosive atmospheres.
 - Check that the electrical system complies with the special electrical explosion protection requirements.
 - Maintenance work in potentially explosive atmospheres may only be carried out by persons with appropriate qualifications.
 - When working on electrical equipment in an explosion-hazard area, only design-approved electrical operating equipment may be used.
- ▷ If the battery symbol appears in the status line of the display, the battery and battery cover should be replaced.
- ▷ Use original spare parts supplied by Elster GmbH, see page 13 (Spare parts), battery, battery cover and opening tool.
- ▷ Carefully open the battery cover as described below in order to avoid damaging the index.
- ▷ Position the tool at an angle of approx. 20°, see fig. 1.

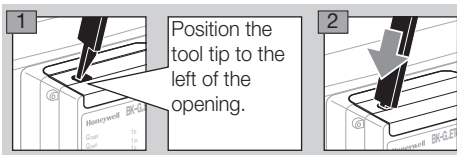

- ▷ Align the tool in a vertical position after breaking the seal.

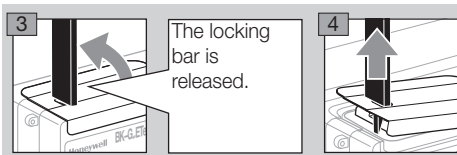

- 5 Navigate to the “Battery exchange” sub-menu in the “Engineer menu”.

- ▷ A PIN must be entered to gain access to the Engineer menu for the index EI5.03.

- 6 Start the battery change procedure.

- ▷ Follow the instructions on the display until you are asked to replace the battery.

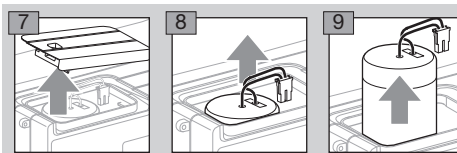

- ▷ Use new battery and new battery cover.

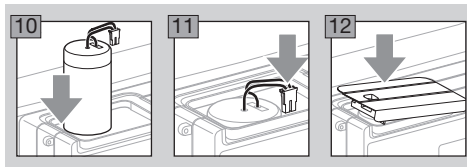

- 13 Engage the battery cover.

- 14 Reseal the battery cover. The body carrying out this task should apply its own seal.

Releasing the valve

- ▷ If a valve is integrated in the diaphragm gas meter BK, this must be released/opened for commissioning.

! CAUTION

To avoid damage:

- Ensure that all residential consumers are closed.
- ▷ The valve can only be released when the optical communications link has been established or via the wireless interface.
- ▷ Unless otherwise agreed, the valve is open on delivery as standard.

Valve open safety check

**CHECK IF
APPLIANCES OFF
HOLD ● FOR GAS**

- 1 Press the selection key ● and hold down.
- ▷ After a short time, the unit switches to initialization mode.

Opening valve

Please wait



- ▷ After successful initialization, the gas flow check is started. The test duration is shown in the display.

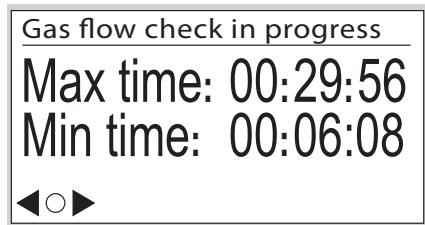

- ▷ The test duration may vary depending on the dimensions of the gas lines downstream of the measuring equipment.
- ▷ Once the release criteria have been checked, the results are shown in the display.



Check test

MID 2014/32/EU prescribes that it must be possible to check the meter.

- ▷ The requirements and test methods must comply with national laws and regulations.
- ▷ The following tests describe the check tests which are carried out by accredited testing agencies.
- ▷ Always conduct a pressure and temperature correction in accordance with established procedures (unit under test against master meter).
- ▷ Measurement accuracy class, see page 13 (Technical data).
- ▷ The unit under test must be acclimatized and installed on the test rig.
- ▷ Maintain the climatic conditions constant during the entire test duration. Otherwise, the test results will be inaccurate.
- ▷ Immediately before the beginning of the test, the quantity of test air, which corresponds to at least 50 x the cyclic volume of the meter to be tested, is fed through the meter at a flow rate of Q_{\max} (maximum flow rate of a gas meter).
- ▷ During an active cyclic test, the display disappears after 5 minutes but lights up every minute for 10 seconds. This function is available for max. 5 hours.
- ▷ To conduct the tests, the thermowell and the pressure test point (if available) can be used as a reference for the temperature and pressure measured by the index.

Legend

F_N	= error of the master meter in %
F_P	= error of the unit under test in %
p_{sp}	= assumed mean gas pressure, see page 13 (Technical data)
p_b	= base pressure in mbar, see page 13 (Technical data)
p_N	= absolute pressure on the master meter in mbar
p_P	= absolute pressure on the unit under test in mbar
$Q_{\max.}$	= maximum flow rate of a gas meter
$Q_{\min.}$	= minimum flow rate of a gas meter
Q_N	= flow on master meter in m^3/h based on the displayed volume V_N
$Q_{act \cdot N}$	= actual flow rate on the master meter in m^3/h
Q_P	= flow determined on unit under test based on V_P in m^3/h
Δt_N	= total master meter testing time in s
Δt_P	= testing time of the unit under test in s
t_b	= base temperature in $^{\circ}C$, see page 13 (Technical data)
T_b	= base temperature in K, $T_b = (273.15 + \{t_b\}) K$
T_{b15}	= base temperature in K for $t_b = 15^{\circ}C$, $T_{b15} = (273.15 + 15) K = 288.15 K$
t_g	= relevant temperature on the unit under test in $^{\circ}C$
T_g	= relevant temperature on the unit under test in K, $T_g = (273.15 + \{t_g\}) K$
T_N	= absolute temperature on the master meter in K
T_P	= absolute temperature on the unit under test in K
V_b	= converted volume with reference to t_b
V_{b15}	= converted volume with reference to $t_b = 15^{\circ}C$
V_N	= displayed volume on master meter in m^3
$V_{act \cdot N}$	= actual volume on master meter in m^3
V_P	= volume on unit under test in m^3 Value after C or U in display, depending on device configuration and test method. See test procedure below for further details.

- ▷ The curly brackets mean "numerical value of".

Cyclic test at a constant flow rate

- ▷ The test rig is in pre-trial operation, i.e. start of measurement on the unit under test will be delayed.
- ▷ Maintain the flow rate constant.
- ▷ The pre-trial flow rate must be the same as the test flow rate.
- ▷ The pre-trial time must be at least 60 seconds. The pre-trial time may be reduced to 20 seconds for higher flow rates ($Q \geq 0.2 Q_{\max.}$).

Test load and minimum test volumes for the test with index readout:

Type	Q _{max.} in m ³ /h	Cyclic volume in dm ³	Test volume in dm ³ at		
			Q _{min.}	0.2 Q _{max.}	Q _{max.}
BK-G1.6	2.5	1.2	1.2	12	60
BK-G2.5	4.0	1.2	1.2	12	60
BK-G4	6.0	1.2	1.2	12	60
BK-G2.5	4.0	2	2	20	100
BK-G4	6.0	2	2	20	100
BK-G6	10	2	2	20	100
BK-G6	10	4	4	40	200
BK-G6	10	6	6	60	300
BK-G10	16	6	6	60	300
BK-G16	25	6	6	60	300
BK-G25	40	12	12	120	600
BK-G40	65	18	18	180	900
BK-G65	100	24	24	240	1200
BK-G100	160	48	48	480	2400

- ▷ The minimum test volumes are recommended guide values. The measurement uncertainty of the complete system (test rig plus unit under test) must not exceed 1/3 of the maximum permissible error (MPE). The testing time must be at least 10 s.
- ▷ In the test procedure described below, it is guaranteed that the unit under test always performs full measuring unit rotations.

Master meter test procedure

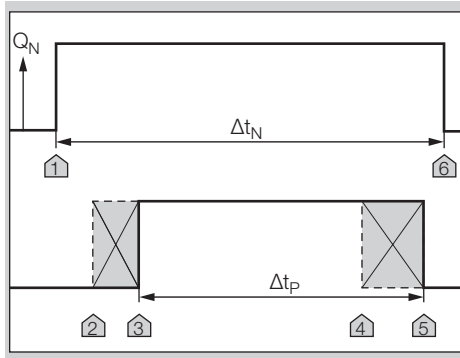

- 1** Set the test flow rate.
 - 2** Start measuring the reference time Δt_N at marker 1.
 - 3** Immediately afterwards, briefly press the selection key ● on the index to start the cyclic test on the unit under test – marker 2. The index will thus be “armed” for measurement.
- ▷ As soon as one of the significant sensor positions has been detected, the unit changes to measuring mode – marker 3.
 - ▷ Once the required minimum testing time has been reached, the measurement can be terminated – marker 4.
- 4** Briefly press the selection key ● in order to end the measurement.

- ▷ Measurement on the unit under test stops automatically once the full number of measuring unit revolutions has been completed – marker 5.
- ▷ Measurement is terminated automatically after 5 hours.

- 5** Stop the test on the master meter – marker 6.
- ▷ The measurements are then available.
 - 6** Read off the flow rate on the master meter or calculate if necessary:
 - a) taking into account the inherent error of the master meter:

$$Q_{act,N} = V_N \times 3600 \text{ s/h} / ((1 + F_N/100) \times \Delta t_N)$$
 - b) If the inherent error of the master meter has already been taken into account in the displayed volume ($V_N = V_{act,N}$):

$$Q_{act,N} = V_{act,N} \times 3600 \text{ s/h} / \Delta t_N$$

- 7** Calculate the flow rate on the unit under test:

$$Q_P = V_P / \Delta t_P.$$
 - 8** The accuracy is checked by comparing the flow rates. The pressure and temperature values of the unit under test corrected with reference to the master meter have already been taken into account here:

$$F_P = 100\% \times ((Q_P \times p_P \times T_N) / (Q_{act,N} \times p_N \times T_P) - 1)$$
- ▷ On a nozzle test rig with a known flow rate, steps 2 and 6 can be omitted.
 - ▷ The error calculation is based on PTB Testing Instructions, Volume 29 “Messgeräte für Gas – Gaszähler” (Measuring instruments for gas – gas meters), Edition 2003.

Cyclic test with a given volume

- ▷ The pre-trial flow rate must be the same as the test flow rate.
- ▷ The pre-trial time must be at least 60 seconds.
- ▷ The pre-trial time may be reduced to 20 seconds for higher flow rates ($Q \geq 0.2 Q_{max.}$).

Test load and minimum test volumes for the test with index readout:

Type	Q _{max.} in m ³ /h	Cyclic volume in dm ³	Test volume in dm ³ at		
			Q _{min.}	0.2 Q _{max.}	Q _{max.}
BK-G1.6	2.5	1.2	36	72	72
BK-G2.5	4.0	1.2	36	72	72
BK-G4	6.0	1.2	36	72	72
BK-G2.5	4.0	2	60	120	120
BK-G4	6.0	2	60	120	120
BK-G6	10	2	60	120	120
BK-G6	10	4	120	240	120
BK-G6	10	6	180	360	360
BK-G10	16	6	180	360	360
BK-G16	25	6	180	360	360
BK-G25	40	12	360	720	720
BK-G40	65	18	540	1080	1080
BK-G65	100	24	720	1440	1440
BK-G100	160	48	1440	2880	288

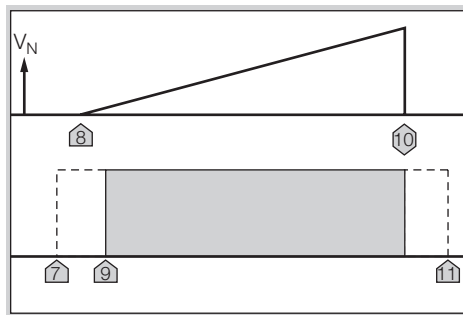

1 To activate the cyclic test on the unit under test, briefly press the selection key ● on the index – marker 7. The index will thus be “armed” for measurement.

2 Start the test on the master meter – marker 8.
 ▷ As soon as one of the significant sensor positions has been detected, the unit changes to measuring mode – marker 9.

3 Test is ended – marker 10.

4 Read off the test results on the unit under test.
 ▷ The measured values are updated with each 1/8 revolution of the measuring unit.

5 Compare the measurement results with the master meter and determine the measuring deviation on the unit under test:

a) taking into account the inherent error of the master meter:

$$F_P = 100\% \times ((V_P \times (1 + F_N/100) \times p_P \times T_N) / (V_N \times p_N \times T_P) - 1)$$

b) If the inherent error of the master meter has already been taken into account in the displayed volume ($V_N = V_{act,N}$), the following applies:

$$F_P = 100\% \times ((V_P \times p_P \times T_N) / (V_{act,N} \times p_N \times T_P) - 1)$$

6 Stop execution of the cyclic test – marker 11. Briefly press the selection key ● twice in order to stop the measurement.

▷ Measurement is terminated automatically after 5 hours.

RTC test

- ▷ The climatic conditions must be maintained constant at $22 \pm 5^\circ\text{C}$ during the entire test duration. Temperature changes in 24 hours $\leq 2\text{ K}$.
- ▷ Ensure that conditions remain sufficiently stable during the measurement.
- ▷ The accuracy of the time count can be verified with this test.

1 Acclimatize the unit under test and place next to the time reference unit.

2 If necessary, activate the time display on both units.

3 Ensure synchronous reading by taking a photo.

4 Observe a min. testing time of 72 hours.

5 Repeat steps **2** and **3**.

6 Accuracy of the clock, see page 13 (Technical data).

Temperature test

- ▷ A temperature test is required on diaphragm gas meters with temperature conversion BK..Te only.
- ▷ The accuracy of the temperature measurement can be verified with this test.
- ▷ The temperature test can only be carried out in Service mode.

! CAUTION

To avoid damage to the unit:

- Comply with ambient temperature, see page 13 (Technical data). Deviations from the permitted ambient temperature will be recorded in the error memory.

▷ Temperature measurement accuracy, see page 13 (Technical data).

1 Install the diaphragm gas meter in a climatic chamber.

2 Activate Service mode – see page 7 (Service mode).

3 Change to the “Cyclic test” menu.

▷ The current gas temperature is displayed.

4 Close the climatic chamber.

5 Select an ambient temperature as a reference value and bring the climatic chamber to this temperature.

▷ To ensure there is also a uniform temperature in the meter, we recommend starting the meter air/gas flow during the temperature adjustment phase.

▷ Ensure that temperature distribution remains uniform and stable during the temperature measurement.





6 Compare the measured value to the temperature reference value.

▷ If required, several reference values can be checked. In this case, repeat the test as of point **5**.

Assistance in the event of malfunction

- ? **Fault**
- ! **Cause**
- **Remedy**

Possible faults and suggested solutions

- ? The  symbol is displayed.
 - ! If the  symbol appears next to a measured value, this means that the value is invalid.
 - After the next time synchronization, the data is recorded again correctly and  disappears.
 - ? When pressing one of the keys, the display remains switched off. A beep can nevertheless be heard.
 - ! Due to excessive use of the index, the average energy consumption has been exceeded and energy-saving mode is active.
 - Leave the index unused for an extended period, e.g. 24 hours. After this, the display will once again be available.
 - ? When pressing one of the keys, the display remains switched off.
 - ! The index is defective.
 - Contact the manufacturer.
 - ? The  symbol is displayed.
 - ! This symbol is only displayed when battery power is low.
 - Replace the battery.
- ▷ In the case of faults which are not described here, contact the manufacturer immediately.

Maintenance

- ▷ For maintenance, refer to the operating instructions for diaphragm gas meters BK-G1.6 to BK-G25 → www.docuthek.com.

Spare parts

The following original spare parts supplied by Elster GmbH are permitted:

Spare parts kit battery pack EI5

Scope of delivery: battery, battery cover and opening tool

Order No.: 72910332

Spare parts kit battery cover EI5

Scope of delivery: battery cover and opening tool

Order No.: 72910366

Technical data

Application with diaphragm gas meters BK..E, BK..ET.
Enclosure: IP 54.

Battery service life: approx. 20 years.

Accuracy of the clock: 9 s/day at 20°C on the day of manufacture.

Clock synchronization with a commissioned Trust Centre will occur:

- Automatically once every 24 hours;
- Upon receipt of a "Set clock" command.

Clock synchronization with a commissioned Trust Centre will not occur:

- Where the time is more than 10 seconds out;
- Where the time is out by more than the "Set clock" command specifies.

Upon which the meter will:

- Log an entry in the security log;
- Send an alert to the communications hub.

Data logger for historic meter readings:

up to 60 weeks in 30-minute intervals.

Optical interface (optional): pursuant to EN 62056-21, Mode (E), Annex B.2.

Communication: 2.4 GHz Zigbee.

The following data can be found on the index:

- base temperature t_b
- specified centre temperature t_{sp}
- max. allowable gas temperature range t_g
- max. allowable ambient temperature range t_m
- max. operating pressure p_{max} .
- base gas pressure p_b (as absolute pressure)
- assumed (inlet) pressure p_{sp} (as absolute pressure)

For more technical data on the diaphragm gas meter BK, see:

Operating instructions for diaphragm gas meters BK-G1.6 to BK-G25 → www.docuthek.com

Logistics

Transport

Diaphragm gas meters are always to be transported in the upright position. On receipt of the product, check that the delivery is complete, see page 2 (Part designations). Report any transport damage immediately.

Storage

Diaphragm gas meters are always to be stored in the upright position and in a dry place. Ambient temperature: see page 13 (Technical data).

Disposal

Meters with electronic components:

Components, particularly batteries, are to be disposed of separately.

On request, old units may be returned carriage paid to the manufacturer, see page 14 (Contact), in accordance with the relevant waste legislation requirements.

Safe disposal of consumption data

All the PCBs, which may contain sensitive software and/or personal data, must be disposed of using a method which ensures that the data cannot be restored (e.g. shredding by a certified waste disposal contractor).

Contact

Honeywell

Germany

Elster GmbH
Strotheweg 1
49504 Lotte
Tel. +49 541 1214-0
Fax +49 541 1214-370
info@elster-instromet.com
www.elster-instromet.com

United Kingdom

Elster Metering Limited
Paton Drive
Tollgate Business Park
Beaconside
Stafford, ST16 3EF
Tel. +44 1785 275200
Fax +44 1785 275305
jeavons.info@gb.elster.com
www.elstermetering.co.uk

Ireland

Active Energy Control Ltd.
Unit 4, Clare Marts
Quin Road
Ennis, Co. Clare
Tel. +353 65 6840600
Fax +353 65 6840610
info@aec.ie
www.aec.ie